

TC3 & DU2 Lens & PCB Dimensions

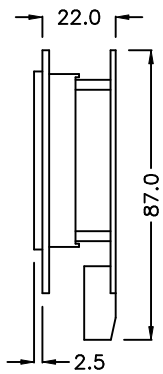

TYPE 2

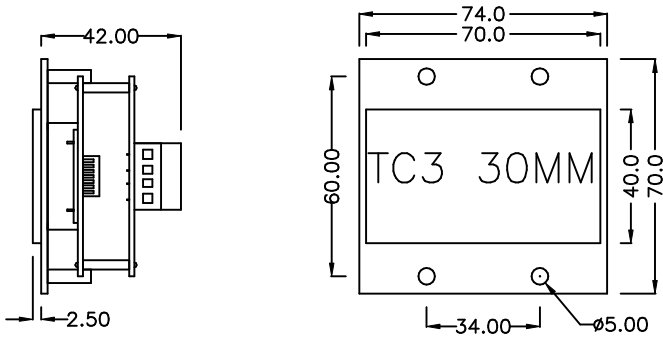
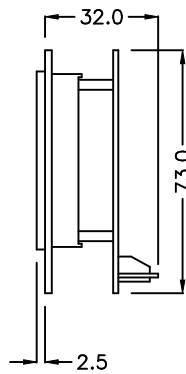

TYPE 1

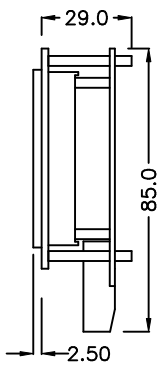
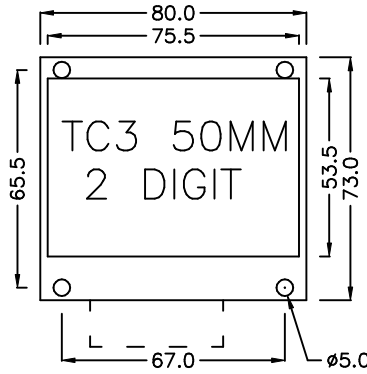

TYPE 2

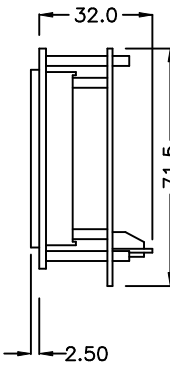

TYPE 1

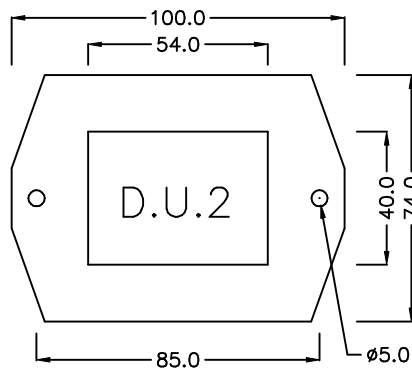
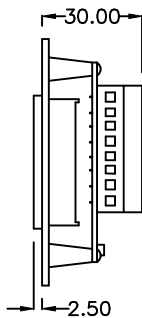
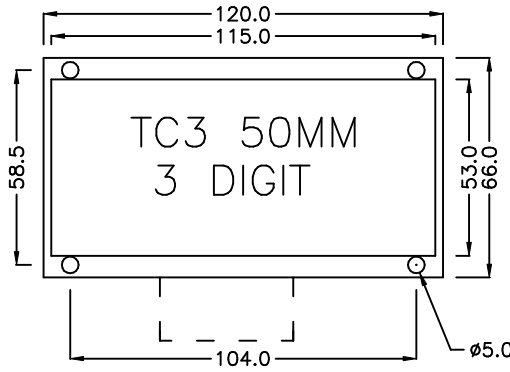

● TC3 30

● TC3 502D

Type 1: Terminal perpendicular PCB

Type 2: Terminal below PCB

● TC3 503D

Type 1: Terminal perpendicular PCB

Type 2: Terminal below PCB

● DU2H